

Thunder Link is a family of small form factor modules for formatting and converting generic digital video streams to standard compliant formats. Different interface standards are supported from the transmitter side including DVI/ HDMI, VGA, 3G-SDI, HD-SDI, SDI, CVBS and USB. Supported physical media are copper and fibre cables.

These modules connect to the digital video interface of Sony's FCB-EV or FCB-EH or Tamron MP series block cameras and support several progressive and interlace HDTV or SDTV formats. As no analog to digital conversion is done on these modules, excellent output image quality is achieved.

TL7050 - Features

- + Supports Sony FCB-EV and FCB-EH Series camera blocks
- + Supports Tamron MP1110M-VC camera block
- + Digital 4Ch./ 8Ch. LVDS video input from camera
- + 1080p and 720p output at 60Hz, 59.94Hz, 50Hz, 30Hz, 29.97Hz and 25Hz
- + 1080i output at 60Hz, 59.94Hz and 50Hz
- + Full automatic video input standard detection
- + Dual 3G/ HD-SDI outputs compliant to SMPTE424M / SMPTE292M
- + DVI video output over HDMI connector
- + Native digital signal processing chain for best image quality
- + Breakout of camera analog HDTV YPbPr and CVBS video*
- + RS232 and TTL level serial control interface
- + Robust RS485 differential serial control interface
- + Supply voltage 12V DC regulated
- + Temperature monitoring with alert function

* requires TL7050 extended cable kit and camera block which supports direct analog YPbPr output.

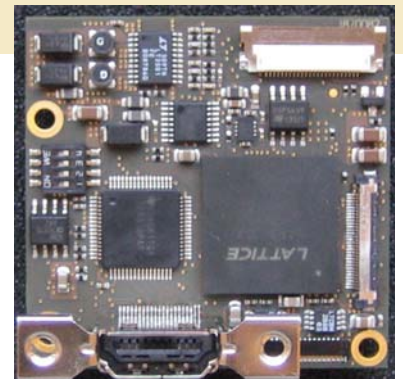

Dual 3G-SDI + DVI (HDMI) Output

Block Diagram TL7050

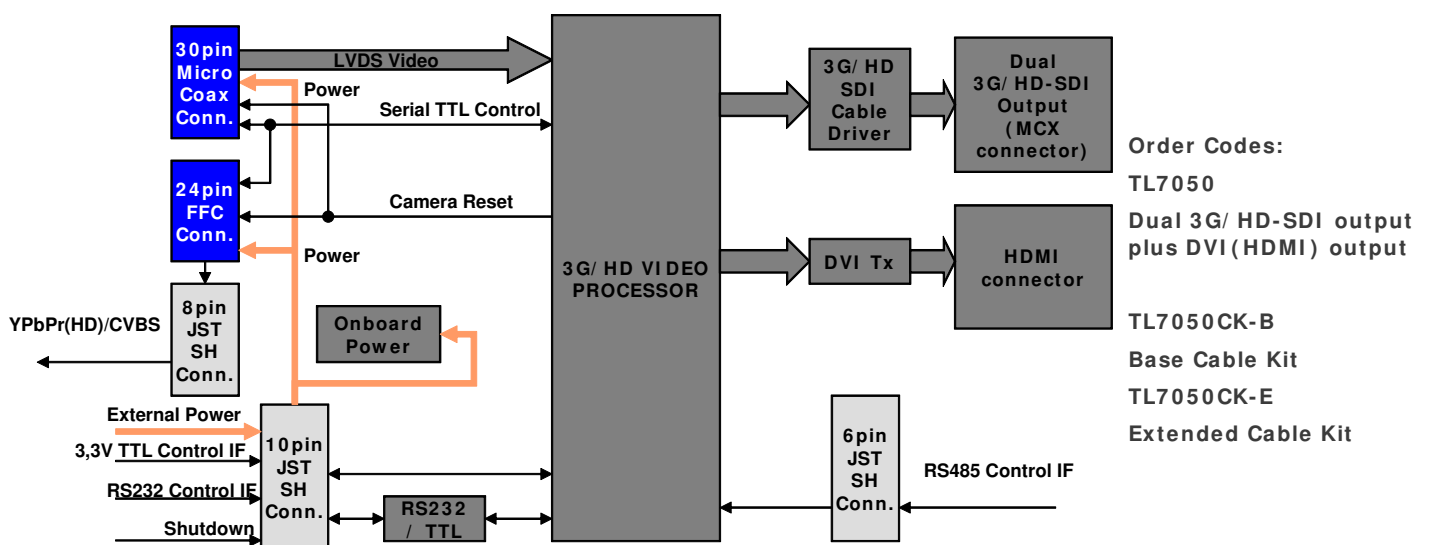

Order Codes:

TL7050

Dual 3G/ HD-SDI output plus DVI(HDMI) output

TL7050CK-B

Base Cable Kit

TL7050CK-E

Extended Cable Kit

This datasheet is valid for all B and C Revision Boards.

Specification Camera Interface

INPUTS:

DATA	8/4 CH. LVDS digital video (from camera)
CLOCK	LVDS (from camera)
CONTROL Rx	3.3V TTL serial control interface
ANALOG	YPbPr and CVBS video 1Vpp into 75 ohms

OUTPUTS:

CONTROL Tx	3.3V TTL serial control interface
RESET	3.3V TTL, active low

Power and Environment

POWER INPUT:

7V to 12V DC regulated (13V DC absolute maximum) for other camera blocks
 Power consumption (FCB-EV7500 + TL7050) 6W (cam motors inactive)
 Power consumption (FCB-EV7100 + TL7050) 6.2 W (cam motors inactive)
 Power consumption (FCB-EV5500 + TL7050) 5.4 W (cam motors inactive)
 Power consumption TL7050: 260mA @ 12V DC (typ.)
 Power consumption value conditions:
 Power 12V DC, video mode 1080p59.94 (720p59.94 for FCB-EV5500)
 Ambient temperature +25°C/77°F
 Humidity 30%

OPERATING CONDITIONS:

Ambient temperature (min/max): -5°C/+60°C = 23°F/140°F
 Humidity: 20%-80%

STORAGE CONDITIONS:

Temperature (min/max): -20°C/+60°C = -4°F/140°F
 Humidity: 20%-80%

Board Mechanical

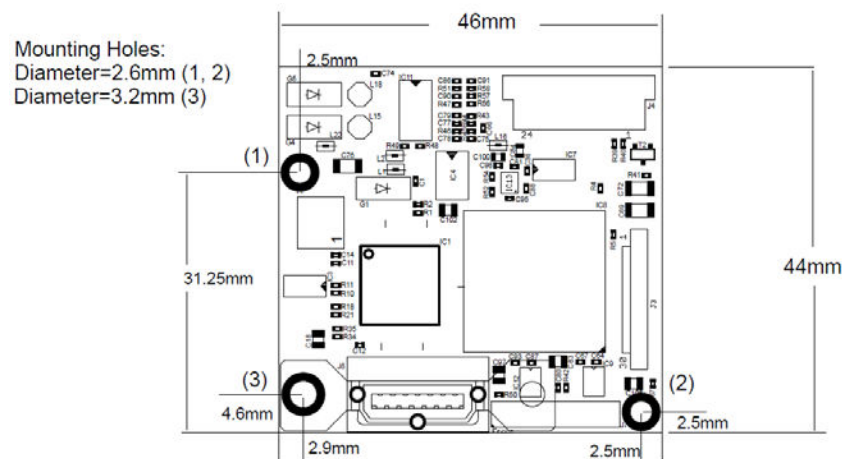

Maximum top component height = 10.5mm (HDMI connector)

Maximum bottom component height = 6.8mm (MCX connectors)

PCB thickness = 1.56mm

POWER INPUT:

7V to 12V DC regulated (13V DC absolute maximum) for other camera blocks

Onboard Connectors

PCB Top Side:

24pin FFC Connector
 (Power, Reset, Serial Control IF, analog Video)
 J4

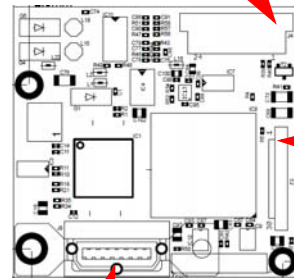

J8
 DVI Output (HDMI connector)

J3
 LVDS Video In,
 Power, Serial Ctrl,
 0.4mm Pitch Micro
 Coaxial Cable

PCB Bottom Side:

Dual 3G/HD-SDI output
 (MCX connector)
 J9 J10

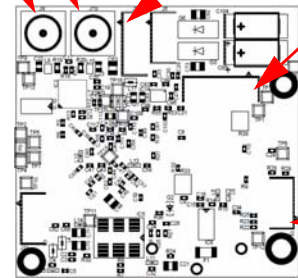

YPbPr, CVBS
 Output
 J5
 Power
 RS232
 TTL
 Shutdown
 J1
 RS485
 J2

Note: Arrowheads indicate pin 1 location

J6: Do not connect

J7: Do not connect

J11: Do not connect

SAFETY NOTES:

FFC with contacts on SAME side MUST be used when connecting J4 of TL7050 to the camera.

All digital inputs are specified for maximum voltages of 3.3V (+5%).

Pin Assignment of external Interfaces

J8 HDMI connector type is Kycon KDMI X_FS1V_WS or equivalent

J1 JST BM10B-SRSS-TB

Power and RS232/ TTL Control IF

- 1 DC IN
- 2 DC IN
- 3 GND
- 4 GND
- 5 Reset / Shut Down, pull to GND to reset/shut down TL7050 and camera*
- 6 GND
- 7 TXD_TTL (serial IF transmit, 3.3V) and/or temperature alert output
- 8 RXD_TTL (serial IF receive, 3.3V)
- 9 RXD_232 (serial IF receive, RS232 level)
- 10 TXD_232 (serial IF transmit, RS232 level)

Note: Connect RS232 or TTL serial interface, not both

J5 JST BM08B-SRSS-TB, analog video from FCB-EHxxxx

Analog component YPbPr and CVBS output **

- 1 Pr
- 2 GND
- 3 Pb
- 4 GND
- 5 Y
- 6 GND
- 7 CVBS
- 8 GND

J9, J10 75 ohms MCX coaxial jack

3G/ HD-SDI outputs

J2 JST BM06B-SRSS-TB

RS485 Control IF **

- 1 TXD_P (to controller)
- 2 TXD_N (to controller)
- 3 RXD_N (from controller)
- 4 RXD_P (from controller)
- 5 GND
- 6 3.45V typ. (max. current 50mA)

* for reset, pull to GND for one second or longer

** requires TL7050 extended cable kit

Onboard Mode Switches

Switch	OFF (default)	ON
1 - cam select	Sony FCB-EV series, Tamron MP1110M-VC	Sony FCB-EH series
2 - cam control	RS232/TTL	RS485
3 - temp alert enable	no alert on J1/ pin7	J1/pin7 alert enabled
4 - mode	Camera	Test pattern*

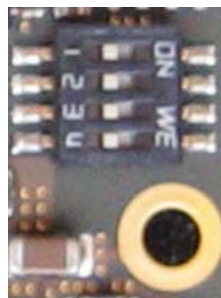

Table 1: Onboard Switch Functions

* Refer to page 7 for test pattern generator operation

POWER INPUT:

7V to 12V DC regulated (13V DC absolute maximum) for other camera blocks

SAFETY NOTES: FFC with contacts on SAME side MUST be used when connecting J4 of TL7050 to the camera. All digital inputs are specified for maximum voltages of 3.3V (+ 5%).

Connection Diagram for FCB-EV, FCB-EH and MP1110 Camera Blocks

TL7050 top side

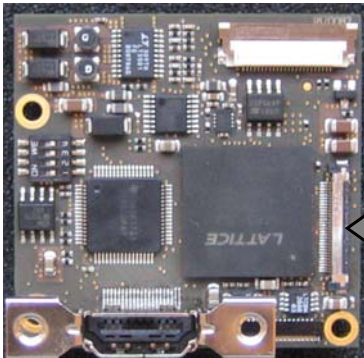

FCB-EV, FCB-EH or MP1110M-VC



30pin micro coaxial cable is included in TL7050 base cable kit.

TL7050 bottom side

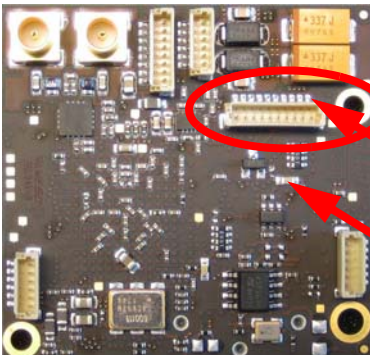

J1, 12V DC Power input, Reset and RS232/ TTL serial interface

Pin 1 location

Temperature alert signalling LED (red colour when on)

Temperature Alert Function

When board temperature exceeds 80°C (176°F), red LED will be switched on.

In addition such an event can be signalled on connector J1/pin7 by setting switch 3 (temp alert enable) to ON position.

- In case board temperature is equal to or over 80°C (176°F), level on J1/pin7 will be held constant low (< 0.4V)
- In case board temperature is less than 80°C (176°F), level on J1/pin7 will be high (> 2.4V)

POWER INPUT:

7V to 12V DC regulated (13V DC absolute maximum) for other camera blocks

SAFETY NOTES: FFC with contacts on SAME side MUST be used when connecting J4 of TL7050 to the camera. All digital inputs are specified for maximum voltages of 3.3V (+5%).

Video Standard Selection Tables for FCB-EV Solutions

The video standard provided by the camera is automatically detected by the TL7050 module.



Camera Setting	TL7050 Output Format	Camera Support
1080i / 50Hz	1080i / 50Hz	FCB-EV7xxx, MP1110M-VC
1080i / 59.94Hz	1080i / 59.94Hz	FCB-EV7xxx, MP1110M-VC
1080i / 60Hz	1080i / 60Hz	FCB-EV7xxx, MP1110M-VC
1080p / 25Hz	1080p / 25Hz	FCB-EV7xxx, MP1110M-VC
1080p / 29.97Hz	1080p / 29.97Hz	FCB-EV7xxx, MP1110M-VC
1080p / 30Hz	1080p / 30Hz	FCB-EV7xxx, MP1110M-VC
1080p / 50Hz	1080p / 50Hz	FCB-EV7xxx, MP1110M-VC
1080p / 59.94Hz	1080p / 59.94Hz	FCB-EV7xxx, MP1110M-VC
1080p / 60Hz	1080p / 60Hz	FCB-EV7xxx, MP1110M-VC
720p / 50Hz	720p / 50Hz	all FCB-EV, MP1110M-VC
720p / 59.94Hz	720p / 59.94Hz	all FCB-EV, MP1110M-VC
720p / 60Hz	720p / 60Hz	all FCB-EV, MP1110M-VC
720p / 25Hz	720p / 25Hz	all FCB-EV, MP1110M-VC
720p / 29.97Hz	720p / 29.97Hz	all FCB-EV, MP1110M-VC
720p / 30Hz	720p / 30Hz	all FCB-EV, MP1110M-VC

Table 2: Video output matrix for TL7050 with FCB-EV and Tamron MP1110M-VC

Camera Monitoring Mode Setting	Camera Register[74] Value (LVDS Mode)
1080p / 60Hz, 59.94Hz or 50Hz	01
All others modes	00

Table 3: Required Camera Register[74] Settings for 1080p60Hz, 1080p59.94Hz and 1080p50Hz operation

Notes:

Refer to Sony FCB-EV or Tamron MP1110M-VC manuals on camera operation and setting adjustments

Refer to Sony FCB-EH series technical manual for model specific video standard support

POWER INPUT:

7V to 12V DC regulated (13V DC absolute maximum) for other camera blocks

SAFETY NOTES: FFC with contacts on SAME side MUST be used when connecting J4 of TL7050 to the camera. All digital inputs are specified for maximum voltages of 3.3V (+ 5%).

Analog Video Output

TL7050 provides analog HDTV YPbPr and analog SDTV CVBS video output signals. These signals are directly taken from the camera.

In some camera modes no or only limited analog video output might be available. Please refer to the related camera documentation.

Reset Operation

When applying power to TL7050, the camera is also automatically powered. During power up all functions on TL7050, are reset and initialized.

During operation a manual reset can be applied by pulling pin no. 5 of connector J1 to 0V (GND). This resets also the camera.

Camera Control

Camera control can be done by connecting a PC or CCU via RS485, RS232 or serial 3.3V TTL interface to TL7050. The interface is passed through to the camera that all VISCA protocol based software can be used.

Serial interface selection must be done by appropriate setting of switch-2.

Cable Kit Contents

TL7050CK-B, Base cable kit:

External connecting cables:

1 pcs. - 10pin flying leads cable for power and control (RS232/TTL), lead length = 15cm / 5.9inch

Camera connecting cables:

1 pcs. - 30pin KEL USL type micro coaxial cable, connector on both sides, length = 20cm / 7.86inch

TL7050CK-E, Extended cable kit for solutions with analog video breakout and RS485 support:

External connecting cables:

1 pcs. - 8pin flying leads cable for analog video, lead length = 15cm / 5.9inch

1 pcs. - 6pin flying leads cable for RS485, lead length = 15cm / 5.9inch

Camera connecting cables:

1 pcs. -24pin flat flex cable, contacts on same side, pitch = 0.5mm, length = 10cm / 3.9inch

POWER INPUT:

7V to 12V DC regulated (13V DC absolute maximum) for other camera blocks

SAFETY NOTES: FFC with contacts on SAME side MUST be used when connecting J4 of TL7050 to the camera. All digital inputs are specified for maximum voltages of 3.3V (+5%).

Test Pattern Generator

TL7050 has an integrated test pattern generator (TPG) which can be operated independent of any camera. The TPG can be enabled by setting onboard switch number 4 to ON position and repowering the TL7050 board. In addition one out of two test pattern and one out of four video standards can be selected by setting onboard switches 1, 2 and 3 accordingly. The following tables summarize all details.

To enable TPG mode, please execute these steps:

1. Set video mode with switches 2 and 3
2. Set pattern with switch 1
3. Set switch 4 to ON to enable TPG mode
4. Switch TL7050 power off and on again

Note: TPG operation can be enabled with or without any camera connected to TL7050

Switch	OFF	ON
4 (TPG on/off)	Camera video output	TPG video output
1 (Pattern)	Multi test pattern	Stress test pattern

Table 4: TPG on/ off and pattern select

	Switch 3 OFF	Switch 3 ON
Switch 2 OFF	1080p 59.94Hz	1080p 50Hz
Switch 2 ON	1080p 29.97Hz	1080p 25Hz

Table 5: Video standard selection

Test Images

Multi Test Pattern



Stress Test



Stress test pattern generates worst case bit cycles on the serial 3G/HD-SDI link. It is suitable to check data/clock recovery performance of any connected 3G/HD-SDI receiver.

POWER INPUT:

7V to 12V DC regulated (13V DC absolute maximum) for other camera blocks