

Dual Link 3 Gbps UHD-SDI Transmitter
Dual Out 3/1.5 Gbps FHD-SDI Transmitter

Data Sheet

PCB Rev.C

Features

- + Video output up to Ultra High Definition
- + Resolution up to 3840x2160p @ 30fps
- + Seamless connection to Sony FCB-ER8550, FCB-ER8530, FCB-ER8300 and FCB-ES8230 4K camera blocks
- + Seamless connection to new Sony FCB-EW9500H camera block
- + Dual Link 3G-SDI output of UHD formats
- + 3G-SDI output of FHD formats
- + 1.5G-SDI output of HD formats
- + Automatic format detection
- + Native signal processing for highest image quality
- + MCX 75 Ohm straight coaxial connectors
- + RS232 and 3.3V TTL level serial camera control interface
- + Supply voltage 9V to 12V DC regulated
- + RoHS and UL/UR compliant

Applications

- + 4K UHD and full HD integrated cameras based on Sony FCB-ER8550, FCB-ER8530, FCB-ER8300, FCB-ES8230 and FCB-EW9500H camera blocks
- + Industrial, medical, security, law enforcement, video production

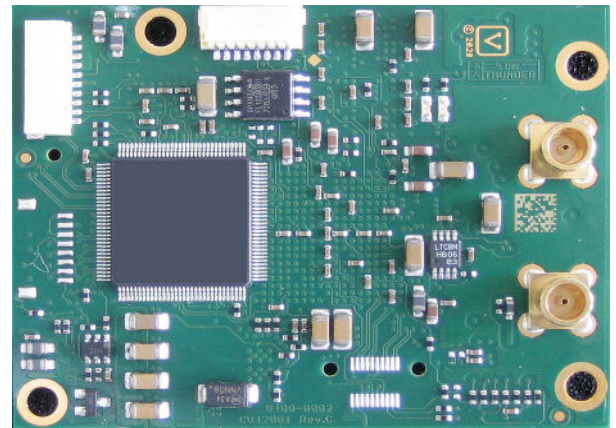

General Description

TL4K1161 is a small form factor serial digital video (SDI) transmitter. Camera video input signals are equalized, processed and output over coaxial connectors. Dual Link 3G-SDI output is compliant to SMPTE ST425-3, 2si mapping, FHD output is compliant to SMPTE ST425-1 level A standards.

Camera control is accomplished by a transparent full duplex communication channel. Physical interface between camera and camera controller / PC is based on RS232 or 3.3V TTL level. TLCK-B-0200 cable kit is available as accessory.

Coaxial Connector Options

TL4K1161-M-ST, Straight MCX (standard version)

TL4K1161-M-RA, Right angle MCX

TL4K1161-D-ST, Straight DIN7A

TL4K1161-D-RA, Right angle DIN7A

TL4K1161-H-ST, Straight HD-BNC

TL4K1161-H-RA, Right angle HD-BNC

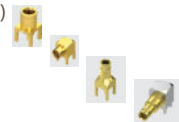

Quick Specification

- FCB-ER/ES/EW series interface on 30pin microcoax connector
- Up to 4K 3840x2160@30fps SDI video output
- Supply voltage 9V to 12V DC
- Operating ambient temperature range -5°C to +60°C
- Operating humidity range 20% to 80%
- Power consumption 3.72W with 12V DC supply voltage
- Power consumption 6.72W with 12V DC supply voltage incl. FCB-ER8530 camera block
- Board size (L x W) 46mm x 60mm
- Wire/cable kit for camera and external interconnect
- RoHS compliant (2002/05/EG and 2011/65/EU)
- UL/UR compliant
- 3D CAD model (step format) available on request

Internet: www.aivion.com

E-Mail: sales@aivion.com

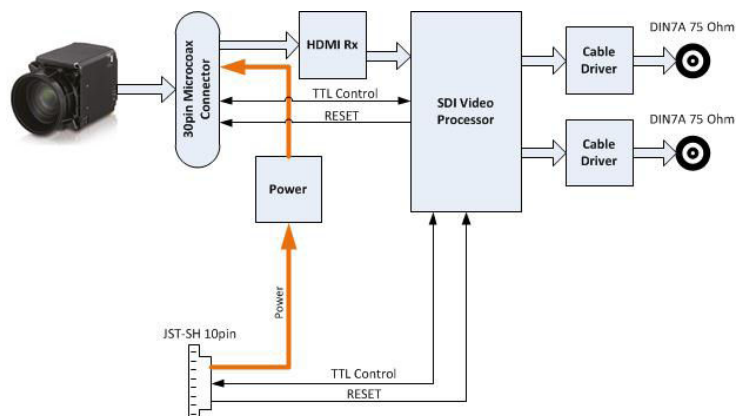

Dual Link 3 Gbps UHD-SDI Transmitter
Dual Out 3/1.5 Gbps FHD-SDI Transmitter

Data Sheet
PCB Rev.C

Board Mechanical (top side)

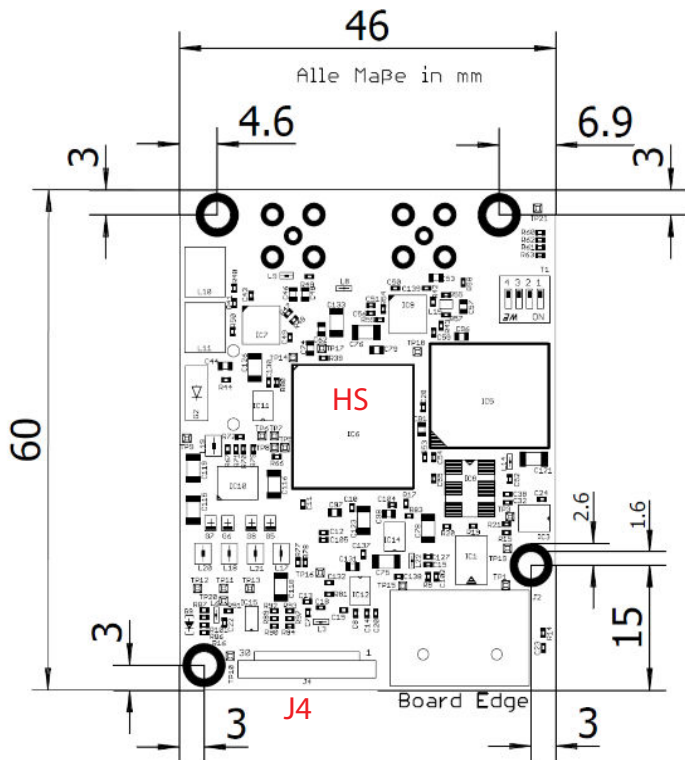

- + Max. component height top side = 4.0mm
 - + Max. component height bottom side = 3.2mm (except J7/J8)
 - + PCB thickness 1.55mm
 - + Mounting holes drill diameter 3,2mm, land diameter 5,2mm
- NOTE:

If ambient temperature is higher than 45°C (113°F), a heat sink should be applied to TL4K1161. Heat sink has to be mounted depending on board installation. It should contact to top or bottom side components marked with **HS**.

Onboard Connectors

- J1: (JST SM10B-SRSS-TB)
- 1 DC Supply voltage input
 - 2 DC Supply voltage input
 - 3 GND (0V)
 - 4 GND (0V)
 - 5 Reset*
 - 6 GND
 - 7 TXD_TTL (serial IF transmit 3.3V)
 - 8 RXD_TTL (serial IF receive 3.3V)
 - 9 RXD_232 (serial IF receive RS232 level)
 - 10 TXD_232 (serial IF transmit RS232 level)
- *Pull pin 5 to GND(0V) for 1ms or longer for reset, leave open for normal operation.

- J3: Not assembled
- J4: HDMI Input (KEL USL00-30L-A)
30wire microcoax connector for FCB-ER8xxx and FCB-EW9500H. Use 30wire micro coaxial cable supplied with cable kit.
- J5: Do not connect (JTAG prog. interface).
- J6: Not assembled

SDI output connectors (Samtec MCX7-J-P-H-ST-TH1):

- J7: Link 1 of DL-3G SDI output or 3G/1.5G-SDI FHD/HD output**
- J8: Link 2 of DL-3G SDI output or 3G/1.5G-SDI FHD/HD output**

Board Bottom Side

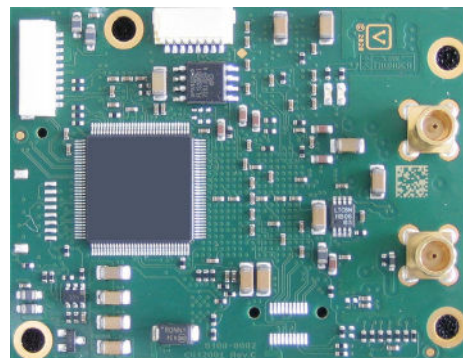
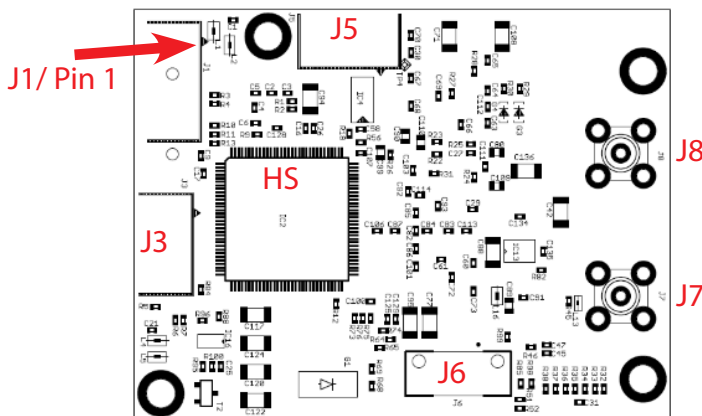

Internet: www.aivion.com
E-Mail: sales@aivion.com

Dual Link 3 Gbps UHD-SDI Transmitter
Dual Out 3/1.5 Gbps FHD-SDI Transmitter

Data Sheet

PCB Rev.C

Board Config Switch

Switch#	OFF	ON
1	RS232 based camera control	3.3V TTL based camera control
2	Keep OFF	Reserved
3	Keep OFF	Reserved
4	Keep OFF	Reserved

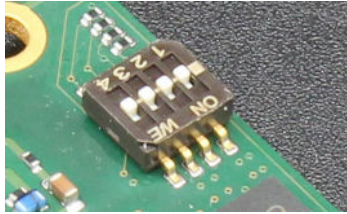

FCB-EW9500H Support

TL4K1161 supports the following video monitoring modes:

- UHD (4MP active) output 2160/p30, 2160p29.97, 2160p25
- FHD output 1080p60, 1080p59.94, 1080p50
- HD output 1080i60 1080i59.94, 1080i50, 1080p30, 1080p29.97, 1080p25, 720p60 720p59.94, 720p50

Note:

FCB-EW9500H outputs 4MP images in UHD formats having a black frame around the active image area. Please refer to Sony FCB-EW9500H technical documentation for details.



Sony FCB-EW9500H

Power and Environment

POWER INPUT:

9V to 12V DC (12.5V DC max.) regulated supply input voltage range

CHARACTERISTICS:

$P_D = 6.72W$ typ. (FCB-ER8530 lens steady +TL4K1161)

$P_{TL4K1161} = 3.72W$ (typ.)

(12V DC supply, 3840x2160@25fps, $T_A = 25^\circ C$, Humidity = 40%)

OPERATING AND STORAGE CONDITIONS:

Ambient temperature (min/max) $-5^\circ C/60^\circ C = 23^\circ F/140^\circ F$

Humidity: 20% - 80%

TL4K1161 is RoHS compliant (2002/05/EG and 2011/65/EU)

Accessories

TLCK-B-0200 Cable Kit:

Kit content:

- 1pcs USL20-30SS-020.0-C KEL USL Cable Harness 30p 20cm 1:n
- 1pcs JST SH cable 10p 15cm flying leads second end 4mm stripped

Board Top Side

